

PHOTON MASS AND PHASE SHIFT EXPERIMENT

ABSTRACT

Results of computations and measurements of energies of X-ray photons emitted from cold plasma, with and without resonant cavity, are presented. The X-ray photon's energy is expressed as a function of the optical-frequency photon's mass. Difference between computed and measured X-ray photons energies is about 1%. Photos taken by X-rays emitted from plasma in the resonant cavity show the phase shift, and the main result of it is an enlargement of images.

INTRODUCTION

Low temperature plasma can emit non-optical frequency photons in the range of X and gamma rays. This phenomenon is explained by Quantum Mass Theory (QMT) {1}. One of the basic assumptions of QMT is the existence of photon mass. It is also assumed that in electron- photon interactions in atoms, electron absorbs photon by incorporating its mass. **This happens when electron's de Broglie waves are resonant with frequency of the incident photon.** {1-2} Thus, **the existence of the photon mass should be expected to be demonstrated by enhancement of the electron mass.** As a consequence of this hypothetical electron-photon interaction process, new plasma effects are predicted. The results of QMT analysis predict the possibility of electron transitions in low temperature plasma, which produce emission of X and gamma ray photons, besides the optical frequency photons.

As a result of photon capture by electron, the electron mass in the energy level with principal quantum number l is: {1}

$$m_{el} = m_{en} + \frac{Z}{\alpha} m_f \quad (1)$$

where m_{en} is the mass of the electron in the energy level with principal quantum number n when $l > n$, m_f is the mass of the photon in the visible range, Z is the atomic number and α is the fine structure constant.

The X-ray photon energy is defined by the equation: {1}

$$E_x = K m_f \quad (2)$$

where K is a constant determined by the expression:

$$K = \frac{1}{\alpha} Z c^2 \hbar \quad (3)$$

and \hbar is Planck's constant, and c is velocity of light in vacuum.

The X-ray photon with this energy will be emitted as a result of the $l - n$ transition of the electron with increased mass, which is a consequence of absorption of the photon mass m_f .

The analysis for the hydrogen atom is developed in more details. Thus, the X-ray photons energies emitted from ionised hydrogen are given by the equation: {1}

$$E_x = \hbar\nu = \frac{1}{\alpha\epsilon_0} \frac{e^4}{8\hbar^2} \left(\frac{m_{el}}{l^2} - \frac{m_{en}}{n^2} \right) \quad (4)$$

where ϵ_0 is electric permittivity of a vacuum.

The mass of the electron in the energy level with principal quantum number l is computed by eqn. (1). By this, the X-ray photon's energy is explicitly expressed by the electron mass enhanced by the absorption of the mass of the visible frequency photon. Thus, the very good accordance between computed and measured E_x could be considered as a strong support of the supposition for existence of photon mass.

The results of the experiments with seven gases prove the validity of the assumption for existence of photon mass, by verifying the prediction for existence of plasma processes which produce emission of non-optical frequency photons. The emitted X and gamma rays were detected and measured by three different methods: GM counters, energy spectrum analyzer and photo-emulsion detection. The difference between measured and computed values of X and gamma ray photons energies is several percents. {1}

The results of the experiments with helium are presented here. Two experiments are explained:

- 1) plasma without resonator for emitted photons, and
- 2) plasma with resonator for emitted photons.

In the second experiment, the plasma tube is placed in a cylinder with reflective inside surface. The metallic and cylindrical tube could be considered as a resonant cavity, because the obtained results show that, in this case, photons with certain energies disappear, photons with other energies appear, while some photons have enhanced counts/seconds.

In these experiments, two types of measurements were used:

- a) photo-emulsion detection, and
- b) measurement of photon's energy by energy spectrum analyzer.

The photos taken by X-rays of lead samples show displaced images of the samples as a result of phase shift which takes place in the plasma with resonant cavity. Besides the intrinsic magnetic and electric fields of the plasma, there are not any external fields applied. As it is shown here, by using Quantum Mass Theory {1}, it is possible to offer an explanation for part of the presented plasma effects. This theory is used only to explain X-ray photons emission from plasma. Because this theory treats photons as particles, it is not possible by this theory to explain the phase shift in these experiments. To explain the phase shift, it is necessary to use Field Theory, and it seems that the most promising approach is to use non-Abelian electrodynamics {3}.

EXPERIMENTAL RESULTS

Fig. 1 shows a tube with ionised helium. Positions denoted by a, b, c and d, e, f show where are placed the photo papers folded into metal aluminum (Al) foil. Two samples of lead are placed over each photo paper. The bigger one has dimensions of 3.0 x 2.5 cm and is 0.3 cm thick. The other sample has dimensions 2 x 2 cm and is also 0.3 cm thick.

From different sections of the tube are emitted X-ray photons with different energies, what shows Fig. 2. For instance, photo e shows that X-rays with lowest energy in this direction are emitted because the images of the lead samples are most distinctive in comparison to the images on the other photos. The photo b taken on the same section of the tube, but in the opposite direction, shows indistinct images of the samples, which

means that there are emitted X-ray photons with energies high enough to go through the lead samples, The photo *f* shows that on this section of the tube, and in this direction of radiation, the emitted X-rays have high enough energy to go through the lead samples so that the images of the lead samples completely disappear.

It has to be pointed out that these photos are negatives. Exposure time is 5 hours.

Fig. 3 shows the tube with ionised helium, placed into a cylindrical reflector, i.e., resonator denoted by *R*. There is a 1 mm wide gap along the cylinder. Positions *d, e, f* are opposite to the cylinder's gap. The positions *a, b, c* are on the other side of the tube where the resonator has no gap, and the photos taken from these positions are omitted because the images of the lead samples are not registered.

Photos presented in the Fig. 4 are taken on the positions *d, e, f* along the gap of the resonator, and they show a very interesting phenomena.

Photo *d* shows a very distinctive image of the bigger sample and only part of the small sample. The images are displaced and twisted. The most interesting fact here, is that the image of the bigger sample has dimensions of 3.3 x 2.8 cm while the dimensions of the sample are 3 x 2.5 cm. The image is larger 23% than the sample.

When more detailed visual analysis of the photo *d* is made, a more complex picture appears, what is graphically presented in the Fig. 5*d'*. Images denoted by 1 and 2 are very indistinctive, however they are on the spots where the samples are placed in this case. The images denoted by 1*a* and 2*a* are displaced, twisted and enlarged in comparison to the samples.

Fig. 4*e* shows displaced images of both lead samples, and graphic presentation of this photo is in the Fig. 5*e'*. The image of the larger lead sample is enlarged 36.5% in comparison with the dimensions of the sample. The image denoted by 2*a* belongs to the small lead sample. However, there are two images with a kind of elliptical shape.

Fig. 4*f* is a photo with no distinctive images of the lead samples and Fig. 5*f'* is a graphic representation of this photo.

The photos Fig. 4*d*, Fig. 4*e* and Fig. 4*f* are taken by the X-rays which are propagating through the gap in the resonant cavity. The exposure time is 0.33 hours, which means 0.06 of the exposure time, when the plasma tube was without a resonator.

The table presents numerical values of the registered energies of the X-ray photons, emitted from the plasma when it is not in the resonator, $|E_{exp}(T)|$, and when it is in the resonator, $|E_{exp}(T_R)|$, and computed values of the photons energies $|E_{th}|$. The difference between computed and measured values of the photon energies is less than 1%.

The data in the table shows that the intensity of radiation with certain photon energies is increased by the resonator. Better accuracy of the computed values of photon energies is also achieved when a resonator is used.

TABLE

E (kev)			Counts/4000sec			
E_{th}	$E_{exp}(T_R)$	(%)	$E_{exp}(T)$	(%)	Tr	T
69.8	69.9	0.1	68.3	2.2	88	66
79.4	78	1.7	78	1.7	83	71
92.4	91	1.5	91	1.5	88	33
99.5	99.1	0.4	99.1	0.4	98	93
122	-	-	121.8	0.2	-	104
139	138	0.7	138	0.7	97	53
146.3	147.7	0.98	146.1	0.1	87	75
154.7	154.2	0.3	152.6	1.3	56	55
158.3	159	0.5	-	-	62	-
164.8	-	-	162.3	1.5	-	43
171.2	173.7	1.4	173.7	1.4	35	13
180.9	178.5	1.3	178.5	1.3	33	47
469.8	465.4	0.95	465.4	0.95	27	13
		0.86		1.1		

REFERENCES

- {1} Petar K. Anastasovski and Trevor M. Benson, Quantum Mass Theory Compatible With Quantum Field Theory, Nova Science Publishers, Inc., New York, 1995
- {2} Petar K. Anastasovski, Theory of Magnetic and Electric Susceptibilities for Optical Frequencies, Nova Science Publishers, Inc., New York, 1990.
- {3} Myron W. Evans, Electrodynamics as a Non-Abelian Gauge Field Theory, Frontier Perspectives, Vol.7, No.2, 1998.

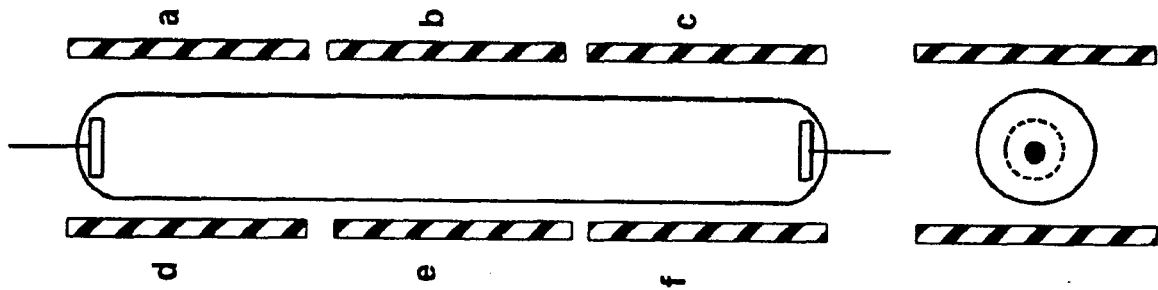

Fig. 1: Plasma tube without resonator for emitted X-ray photons. Positions where are placed photo papers folded into metal foil, are denoted *a* to *f*.

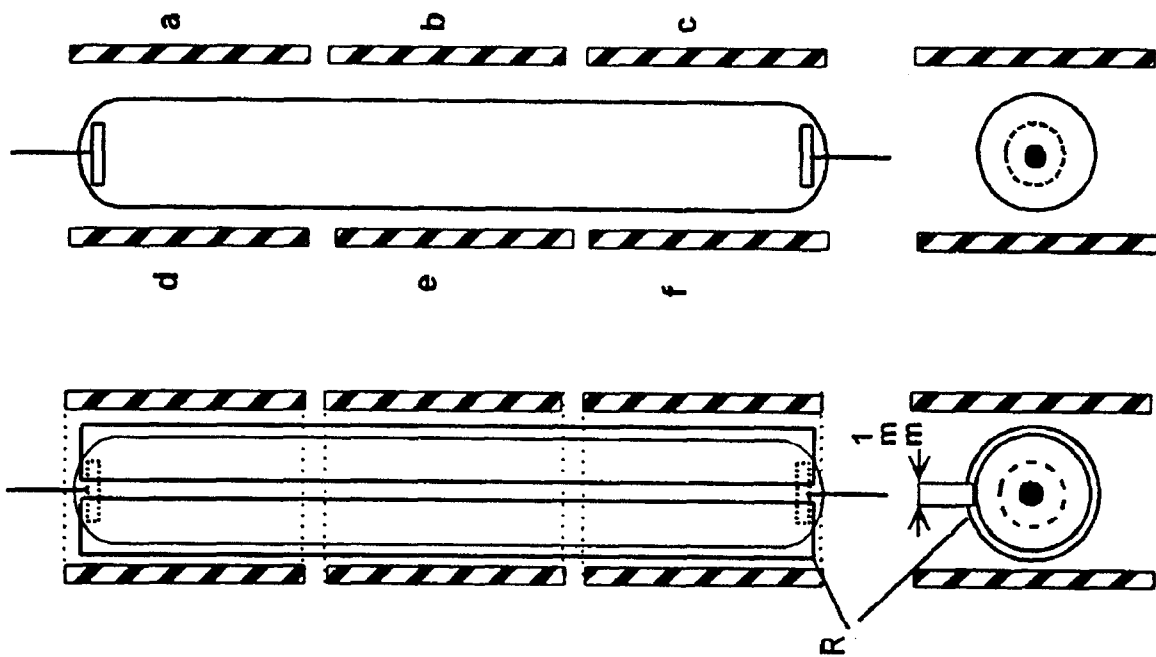

Fig. 3: Plasma tube in the resonant cavity denoted by *R*, with 1 mm wide gap along it.

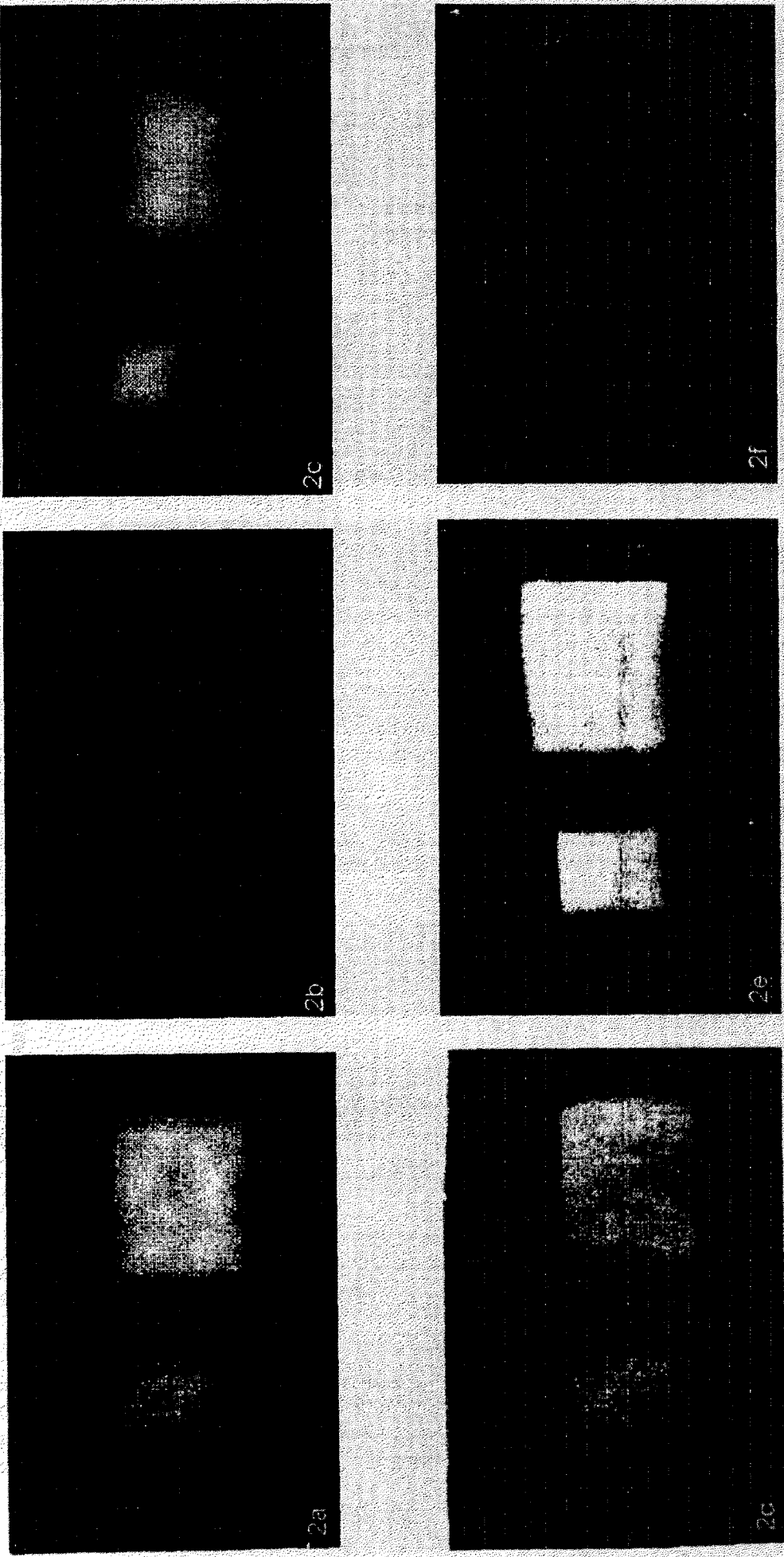
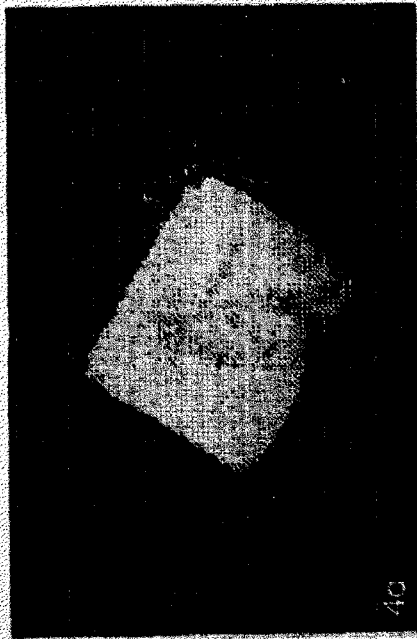
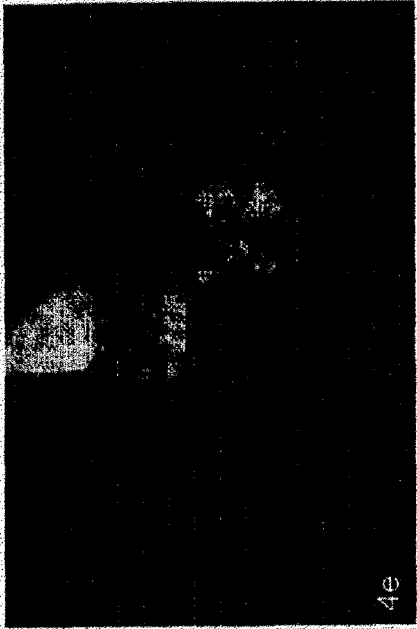

Figure 2: Photos taken by X-rays emitted from the *Hf*e plasma tube. The photos represent the obtained images of two lead samples, taken in the marked places along the plasma tube.



4c



4e

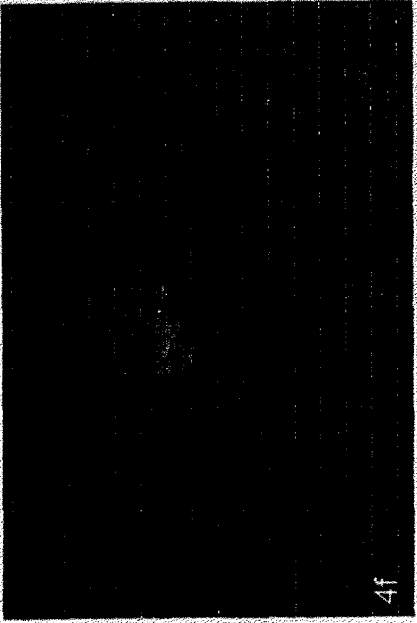

4f

Figure 4: Photos taken by X-rays emitted from *He* plasma tube with resonator with gap of 1 mm, along the resonant cavity. The photos represent the obtained images of the same two lead samples as in the Fig.2, and in the same positions of the photo paper folded into metal foil.

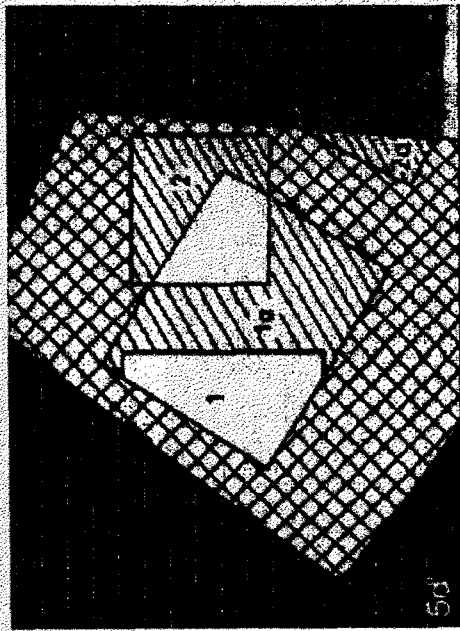

5d

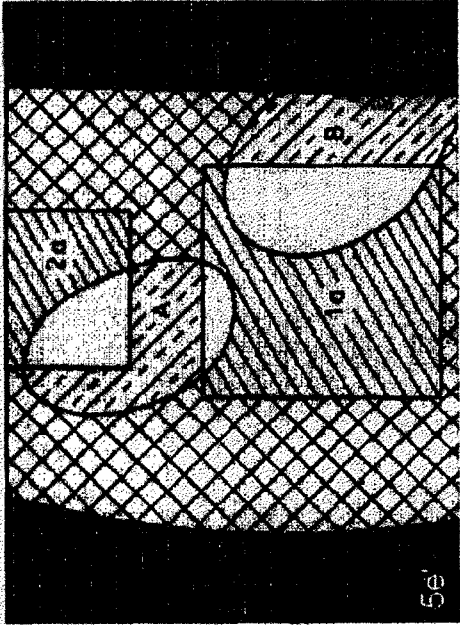

5e

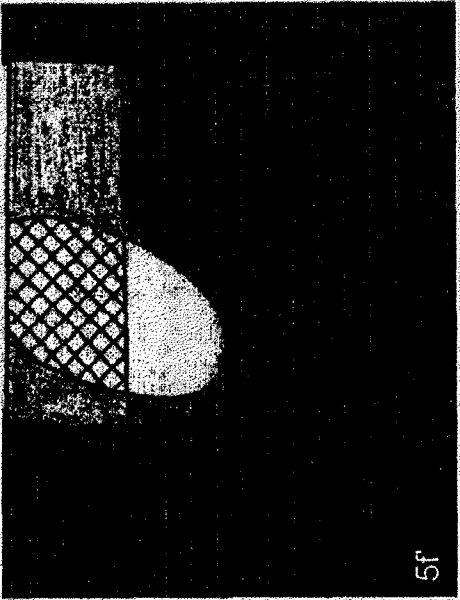

5f

Figure 5: Graphic representation of the images from the photos of Fig. 4.